

## Data sheet | Item number: 769-603/006-000

1-conductor male connector; Snap-in flange; 4 mm<sup>2</sup>; Pin spacing 5 mm; 3-pole

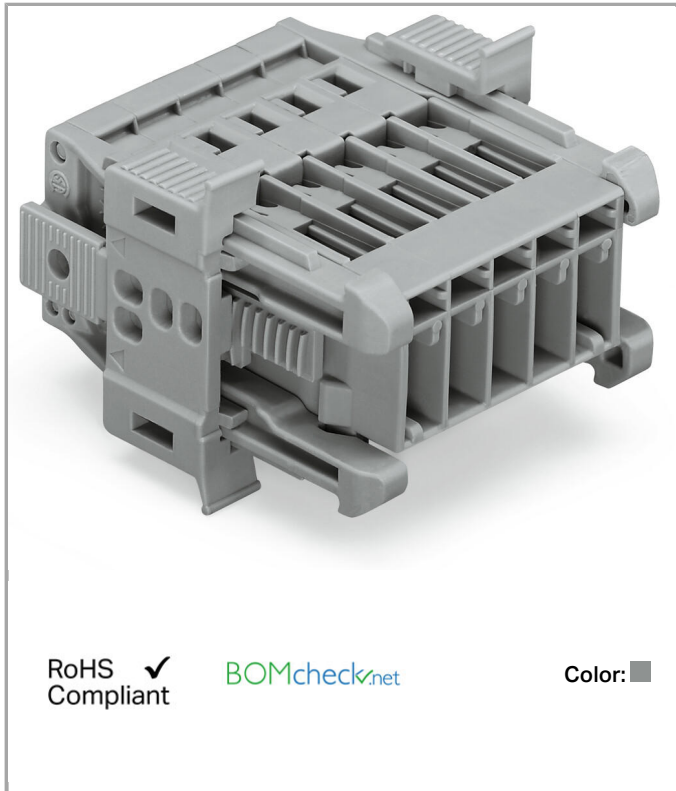

769-603/006-000



RoHS  Compliant

[BOMcheck.net](https://www.bomcheck.net)

Color: ■

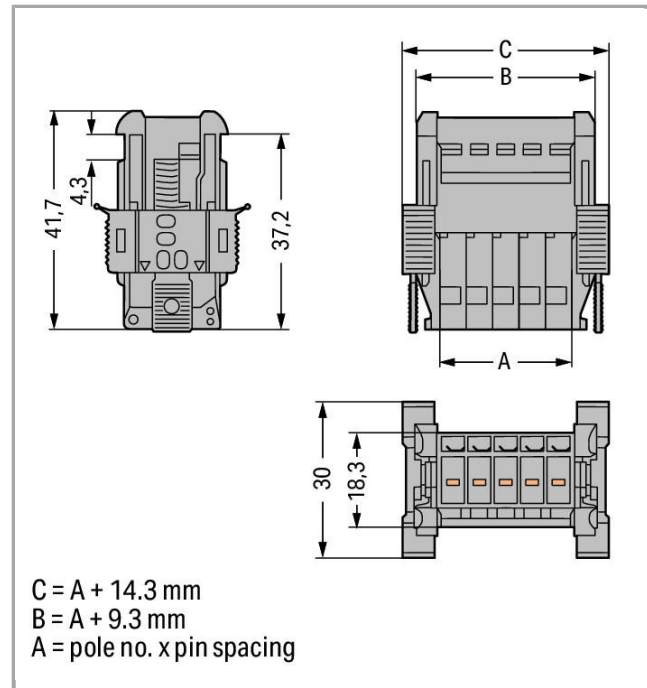

### Data

#### Electrical data

#### Ratings per IEC/EN 60664-1

Rated voltage (III / 3)	500 V
Rated impulse voltage (III / 3)	6 kV
Rated current	32 A

#### Connection data

Connection technology	CAGE CLAMP®
Actuation type	Operating tool
Connectable conductor materials	Copper
Nominal cross section	4 mm <sup>2</sup>
Solid conductor	0.08 ... 4 mm <sup>2</sup> / 28 ... 12 AWG
Fine-stranded conductor	0.08 ... 4 mm <sup>2</sup> / 28 ... 12 AWG
Strip length	8 ... 9 mm / 0.31 ... 0.35 inch

No. of poles	3
Total number of connection points	3
Total number of potentials	3
Type of wiring	Side-entry wiring

### Geometrical Data

Pin spacing	5 mm / 0.197 inch
Width	29.3 mm / 1.154 inch
Height	30 mm / 1.181 inch
Depth	41.7 mm / 1.642 inch

### Mechanical data

Mounting type	Snap-in
---------------	---------

### Plug connection

Contact type (pluggable connector)	Male connector/plug
Connector connection type	for conductors

### Material Data

Color	gray
Insulating material	Polyamide 66 (PA 66)
Fire load	0.337 MJ
Weight	14.175 g

### Commercial data

Product Group	18 (X-COM-System)
Country of origin	PL
GTIN	4045454917005
Customs Tariff No.	85366990990

### Approvals / Certificates



#### Country specific Approvals

Logo	Approval	Additional Approval Text	Certificate name
	CCA DEKRA Certification B.V.	EN 61984	2190419.02
	CCA DEKRA Certification B.V.	IEC 61984	NL-47799
	CSA	C22.2 No. 158	1101144



DEKRA Certification B.V.

## UL-Approvals



Logo	Approval	Additional Approval Text	Certificate name
	UR Underwriters Laboratories Inc.	UL 1977	E45171
	UR Underwriters Laboratories Inc.	UL 1059	E45172

## Compatible products



## tools

	<b>Item no.: 210-490</b> Operating tool; for female and male connectors with CAGE CLAMP® connection	210-490
	<b>Item no.: 769-434</b> Push-button; loose; for female and male connectors with CAGE CLAMP® connection	769-434

## Insulation stop

	<b>Item no.: 769-470</b> Insulation stop; 0.08 - 0.2 mm² "s" (0.14 mm² "f-st"); 5 pieces/strip	769-470
	<b>Item no.: 769-471</b> Insulation stop; 0.25 - 0.5 mm²; 5 pieces/strip	769-471
	<b>Item no.: 769-472</b> Insulation stop; 0.75 - 1 mm²; 5 pieces/strip	769-472

## Strain relief plate

	<b>Item no.: 769-410</b> Strain relief plate	769-410
	<b>Item no.: 769-411</b> Strain relief plate	769-411

## Protective Warning Marker



**Item no.: 280-415**  
Protective warning marker; with high-voltage symbol, black; for 5 terminal blocks

280-415

## ferrule



**Item no.: 216-101**  
Ferrule; Sleeve for 0.5 mm<sup>2</sup> / AWG 22; uninsulated; electro-tin plated

216-101



**Item no.: 216-102**  
Ferrule; Sleeve for 0.75 mm<sup>2</sup> / AWG 20; uninsulated; electro-tin plated

216-102



**Item no.: 216-103**  
Ferrule; Sleeve for 1 mm<sup>2</sup> / AWG 18; uninsulated; electro-tin plated

216-103



**Item no.: 216-104**  
Ferrule; Sleeve for 1.5 mm<sup>2</sup> / AWG 16; uninsulated; electro-tin plated

216-104



**Item no.: 216-201**  
Ferrule; Sleeve for 0.5 mm<sup>2</sup> / 20 AWG; insulated; electro-tin plated

216-201



**Item no.: 216-202**  
Ferrule; Sleeve for 0.75 mm<sup>2</sup> / 18 AWG; insulated; electro-tin plated

216-202



**Item no.: 216-203**  
Ferrule; Sleeve for 1 mm<sup>2</sup> / AWG 18; insulated; electro-tin plated

216-203



**Item no.: 216-204**  
Ferrule; Sleeve for 1.5 mm<sup>2</sup> / AWG 16; insulated; electro-tin plated

216-204



**Item no.: 216-206**  
Ferrule; Sleeve for 2.5 mm<sup>2</sup> / AWG 14; insulated; electro-tin plated

216-206

## Female plug



**Item no.: 769-101**  
1-conductor female plug; 4 mm<sup>2</sup>; 1-pole

769-101



**Item no.: 769-101/000-016**  
1-conductor female plug; 4 mm<sup>2</sup>; 1-pole

/000-016

769-101



**Item no.: 769-102**  
1-conductor female plug; 4 mm<sup>2</sup>; 2-pole

769-102



**Item no.: 769-102/000-036**  
1-conductor female plug; 4 mm<sup>2</sup>; 2-pole

/000-036

769-102



**Item no.: 769-102/000-037**  
1-conductor female plug; 4 mm<sup>2</sup>; 2-pole

/000-037

769-102



**Item no.: 769-103**  
1-conductor female plug; 4 mm<sup>2</sup>; 3-pole















769-103

















**Item no.: 769-103/000-036**  
1-conductor female plug; 4 mm<sup>2</sup>; 3-pole

/000-036

769-103

	<b>Item no.: 769-103/000-037</b> 1-conductor female plug; 4 mm <sup>2</sup> ; 3-pole	769-103 /000-037
	<b>Item no.: 769-103/000-038</b> 1-conductor female plug; 4 mm <sup>2</sup> ; 3-pole	769-103 /000-038
	<b>Item no.: 769-103/000-039</b> 1-conductor female plug; 4 mm <sup>2</sup> ; 3-pole	769-103 /000-039
	<b>Item no.: 769-103/021-000</b> 1-conductor female plug; Locking lever; 4 mm <sup>2</sup> ; 3-pole	769-103 /021-000
	<b>Item no.: 769-121</b> 2-conductor female connector; 4 mm <sup>2</sup> ; 1-pole	769-121
	<b>Item no.: 769-121/000-016</b> 2-conductor female connector; 4 mm <sup>2</sup> ; 1-pole	769-121 /000-016
	<b>Item no.: 769-122</b> 2-conductor female connector; 4 mm <sup>2</sup> ; 2-pole	769-122
	<b>Item no.: 769-123</b> 2-conductor female connector; 4 mm <sup>2</sup> ; 3-pole	769-123
<b>Marking accessories</b>		
	<b>Item no.: 2009-145</b> Mini-WSB Inline; for Smart Printer; on reel; stretchable 5 - 5.2 mm; plain; snap-on type	2009-145
	<b>Item no.: 2009-145/000-002</b> Mini-WSB Inline; for Smart Printer; on reel; stretchable 5 - 5.2 mm; plain; snap-on type	2009-145 /000-002
	<b>Item no.: 2009-145/000-005</b> Mini-WSB Inline; for Smart Printer; on reel; stretchable 5 - 5.2 mm; plain; snap-on type	2009-145 /000-005
	<b>Item no.: 2009-145/000-006</b> Mini-WSB Inline; for Smart Printer; on reel; stretchable 5 - 5.2 mm; plain; snap-on type	2009-145 /000-006
	<b>Item no.: 2009-145/000-007</b> Mini-WSB Inline; for Smart Printer; on reel; stretchable 5 - 5.2 mm; plain; snap-on type	2009-145 /000-007
	<b>Item no.: 2009-145/000-012</b> Mini-WSB Inline; for Smart Printer; on reel; stretchable 5 - 5.2 mm; plain; snap-on type	2009-145 /000-012
	<b>Item no.: 2009-145/000-023</b> Mini-WSB Inline; for smartPRINTER; on reel; stretchable 5 - 5.2 mm; plain; snap-on type	2009-145 /000-023

	<b>Item no.: 2009-145/000-024</b> Mini-WSB Inline; for Smart Printer; on reel; stretchable 5 - 5.2 mm; plain; snap-on type	2009-145
		7000-024
	<b>Item no.: 210-831</b> Marking strips; on reel; 2.3 mm wide; plain; Self-adhesive	210-831
	<b>Item no.: 210-832</b> Marking strips; on reel; 3 mm wide; plain; Self-adhesive	210-832
	<b>Item no.: 210-833</b> Marking strips; on reel; 6 mm wide; plain; Self-adhesive	210-833
	<b>Item no.: 210-834</b> Marking strips; on reel; 5 mm wide; plain; Self-adhesive	210-834
	<b>Item no.: 248-501</b> Miniature WSB Quick marking system; plain; Marker width 5 mm; 10 strips with 10 markers per card	248-501
	<b>Item no.: 248-501/000-002</b> Mini-WSB marking card; as card; not stretchable; plain; snap-on type	248-501
		7000-002
	<b>Item no.: 248-501/000-005</b> Mini-WSB marking card; as card; not stretchable; plain; snap-on type	248-501
		7000-005
	<b>Item no.: 248-501/000-006</b> Mini-WSB marking card; as card; not stretchable; plain; snap-on type	248-501
		7000-006
	<b>Item no.: 248-501/000-007</b> Mini-WSB marking card; as card; not stretchable; plain; snap-on type	248-501
		7000-007
	<b>Item no.: 248-501/000-012</b> Mini-WSB marking card; as card; not stretchable; plain; snap-on type	248-501
		7000-012
	<b>Item no.: 248-501/000-017</b> Mini-WSB marking card; as card; not stretchable; plain; snap-on type	248-501
		7000-017
	<b>Item no.: 248-501/000-023</b> Mini-WSB marking card; as card; not stretchable; plain; snap-on type	248-501
		7000-023
	<b>Item no.: 248-501/000-024</b> Mini-WSB marking card; as card; not stretchable; plain; snap-on type	248-501
		7000-024
<b>Coding</b>		
	<b>Item no.: 769-435</b> Coding pin; for coding of female plugs; for carrier terminal blocks / male connectors	769-435



## Downloads

### Documentation

#### Bid Text

---

769-603/006-000	doc 25.6 kB	Download
-----------------	----------------	----------

---

## CAD/CAE - Smart Data

### CAD data

---

3D Download 769-603/006-000	URL	Download
-----------------------------	-----	----------

---

## Product family

### X-COM

[Learn more about the product family.](#)

[Show all products from the family](#)

Subject to changes.

---